

### Features

- Vitreous China.
- Comfort Height® Elongated Bowl.
- Revolution 360™ swirl flushing system powered by AquaPiston®.
- Includes left-hand polished chrome trip lever.
- 1.28 gpf (4.8 lpf).
- 2-1/8" (54 mm) fully glazed skirted trapway.
- Patented ReadyLock™ installation system.
- 12" (305 mm) rough-in.
- CleanCoat® surface coating.
- Less seat and supply.
- 9-3/4" (248 mm) x 7-1/4" (184 mm) water area.
- 29 1/2" (749 mm) x 16-1/2" (419 mm) x 31-3/8" (797 mm).
- Floor mount / Floor outlet.

### Recommended Accessories

- K-4008 Reveal® Quiet-Close™ Elongated Toilet Seat
- K-4108 C3®-230 Elongated Cleansing Toilet Seat
- K-7637 Angle Supply with Stop (single)
- K-5383 10" Rough-in Full Skirt Trap and Attachment System
- K-5381 14" Rough-in Full Skirt Trap and Attachment System
- K-20120-L Trip Lever

### Components

Product includes:

- K-4143 Toilet Tank
- K-4144 Elongated Toilet Bowl
- Additional included component/s: Tank Cover, Trip Lever, and ReadyLock™ installation system.



ADA CSA B651 OBC

### Codes/Standards







ASME A112.19.2/CSA B45.1  
DOE - Energy Policy Act 1992  
EPA WaterSense®  
California Energy Commission (CEC)  
ADA  
ICC/ANSI A117.1  
CSA B651  
OBC

### KOHLER® One-Year Limited Warranty

See website for detailed warranty information.

### Available Color/Finishes

*Color tiles intended for reference only.*

| Color  | Code | Description  |
|--|------|--------------|
|  | 0    | White        |
|  | 96   | Biscuit      |
|  | NY   | Dune         |
|  | 95   | Ice™ Grey    |
|  | G9   | Sandbar      |
|  | 7    | Black Black™ |

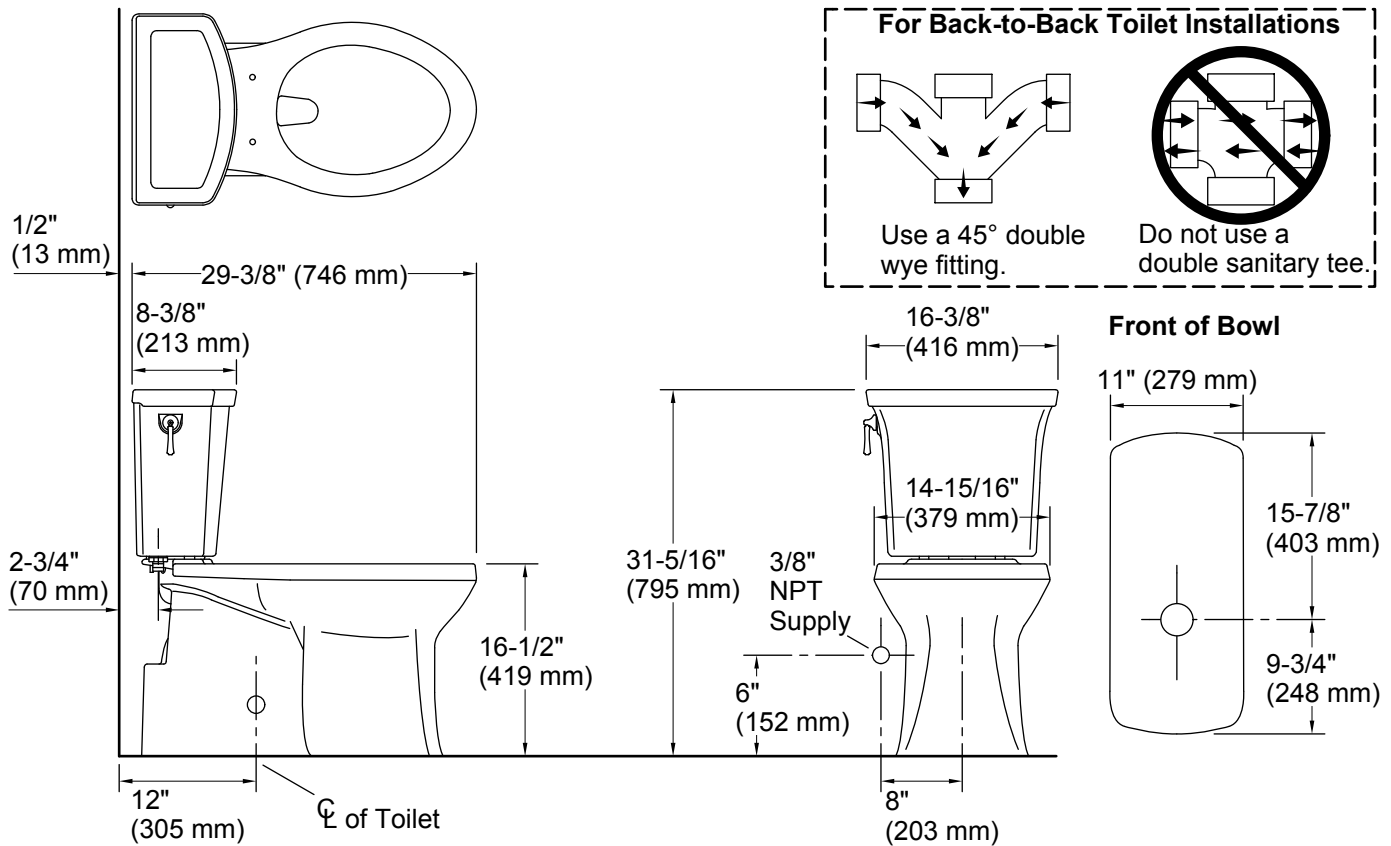

### Technical Information

All product dimensions are nominal.

|                       |                                   |
|-----------------------|-----------------------------------|
| Toilet type:          | Two-piece, Floor-mount            |
| Waste Outlet:         | Floor                             |
| Bowl shape:           | Elongated front                   |
| Flush type:           | Gravity siphon jet                |
| Trap passageway:      | 2-1/8" (54 mm)                    |
| Water Consumption     |                                   |
| Full:                 | 1.28 gpf (4.8 lpf)                |
| Water surface size:   | 9-3/4" x 7-1/4" (248 mm x 184 mm) |
| Rim to water surface: | 6-1/4" (159 mm)                   |

### Fixture Supply Requirements

|                      |                    |
|----------------------|--------------------|
| Min static pressure: | 15 psi (103.4 kPa) |
| Max static pressure: | 80 psi (551.6 kPa) |

### Notes

Install this product according to the installation instructions.

For back-to-back toilet installations: Use only a 45° double wye fitting.

ADA, OBC, CSA B651 compliant when installed to the specific requirements of these regulations.

Plumbing codes may require elongated toilets and elongated, open-front seats in public bathrooms.

Accessibility standards may require controls to be located on the open side of the toilet.