

Features

- Round strainer shower drain
- For use with acrylic, fiberglass, cast iron, or Vikrell® shower bases

Material

- Solid-brass construction for durability and reliability

Installation

- For use with 2" metal or plastic pipe; includes 2" plastic pipe gasket/bushing

Recommended Products/Accessories

K-23726 Drain treatment



Codes/Standards









ASME A112.18.2/CSA B125.2

KOHLER® One-Year Limited Warranty

See website for detailed warranty information.

Available Colors/Finishes

Color tiles intended for reference only.

Color	Code	Description
	CP	Polished Chrome
	SN	Vibrant® Polished Nickel
	AF	Vibrant® French Gold
	BN	Vibrant® Brushed Nickel
	BV	Vibrant® Brushed Bronze
	BL	Matte Black
	2MB	Vibrant® Brushed Moderne Brass
	TT	Vibrant Titanium
	BGP	Vibrant Brushed Graphite
	DR	Deep Bronze

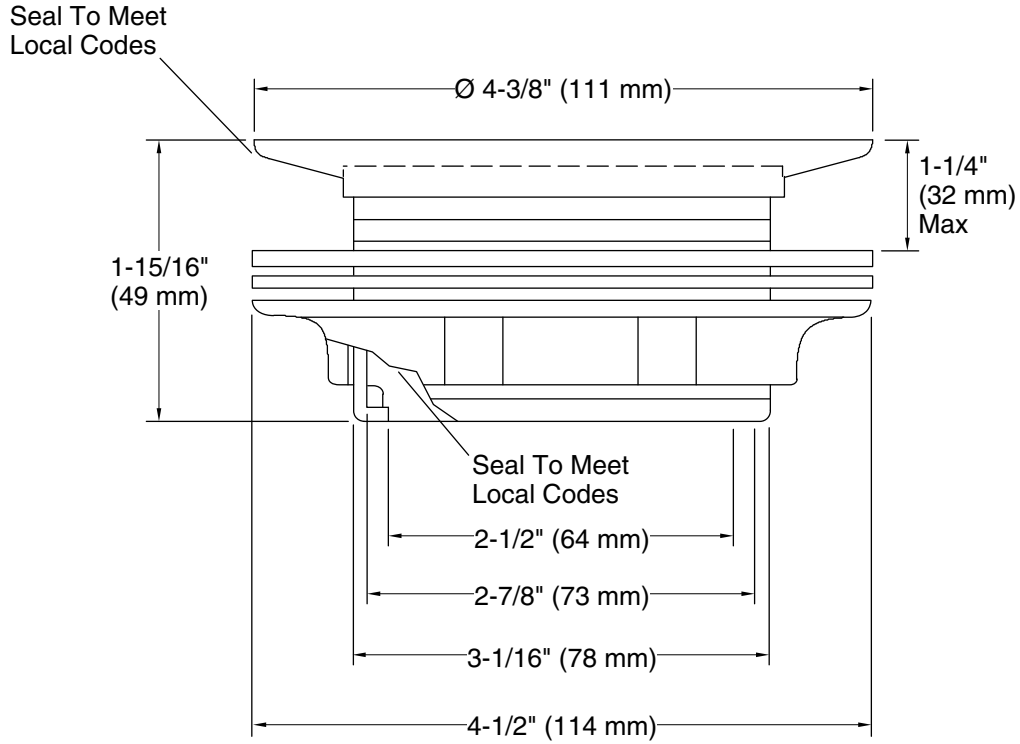

Technical Information

All product dimensions are nominal.

Material: Brass

Notes

Install this product according to the installation instructions.