



260 North Elm Street • Westfield, MA 01085
Tel: (413) 562-5423 • Fax: (413) 572-3764
www.beacon-morris.com

7555 Tranmere Drive • Mississauga, Ontario L5S 1L4 Canada
Tel: (905) 670-5888 • Fax: (905) 670-5782
www.mestekcanada.com



TWIN-FLO III®

Kickspace Heaters

Three sizes to meet a wide range of heating needs

Twin-Flo III® kickspace heaters are your ideal solution wherever space is limited:

- Under Cabinets
- In Kitchens, Baths, and Foyers
- Under Stair Risers and Windows

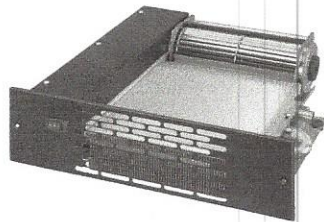

Model K42

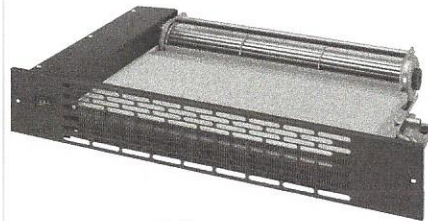

Model K84

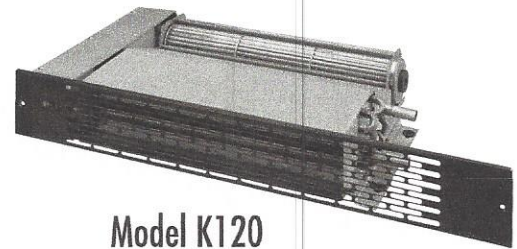

Model K120

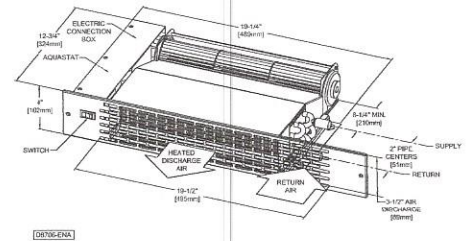
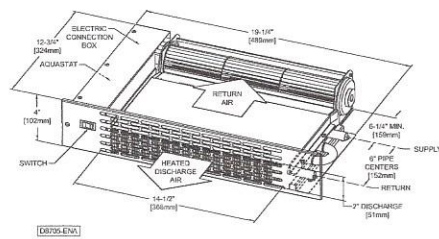
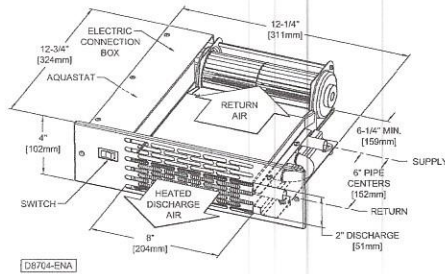

Heating Capacity (BTU/Hr.*) for All Twin-Flo III Models

Entering Water Temperature (°F)	WATER FLOW RATE (GALLONS PER MINUTE)								
	1 Gal.			2 Gal.			3 Gal.		
	Model 42	Model 84	Model 120	Model 42	Model 84	Model 120	Model 42	Model 84	Model 120
**110	1480	3370	8425	1520	3440	8535	1560	3515	8730
120	1800	4055	8875	1840	4145	8995	1875	4230	9205
130	2175	4770	9330	2220	4875	9455	2260	4980	9680
140	2590	5540	9780	2640	5670	9915	2690	5795	10150
150	3050	6300	10230	3120	6440	10375	3190	6585	10625
160	3510	7000	10685	3590	7155	10835	3670	7310	11100
170	3895	7730	11135	3980	7900	11295	4065	8070	11570
180	4278	8460	11585	4375	8650	11755	4470	8840	12045
190	4660	9180	12035	4770	9390	12215	4875	9600	12520
200	5015	9910	12490	5127	10135	12675	5240	10360	12990
Friction Loss (head)	.17 ft.	.22 ft.	.43 ft.	.8 ft.	.95 ft.	1.45 ft.	1.2 ft.	1.5 ft.	2.97 ft.

*Based on 65°F entering air temperature with fan at high speed including the heating effect factor. Ratings reduced by 15% at low speed.
**Blower operates at water temperature above 120°F with standard self-contained aquastat. Optional low temperature aquastat (110°F–95°F) available for low temperature applications. Supply and return connections are 1/2" nominal. Units are not recommended for use with steam.

TWIN-FLO III®

Installation Kits

Provide convenient, flexible installation options

Beacon/Morris offers kits for installing Twin-Flo III units in locations other than the kickspace under a cabinet. Each kit comes with all the hardware needed to install the kickspace heater.

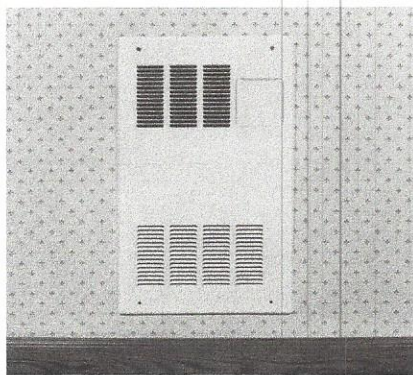

Recessed models finished in Eggshell with round edges.

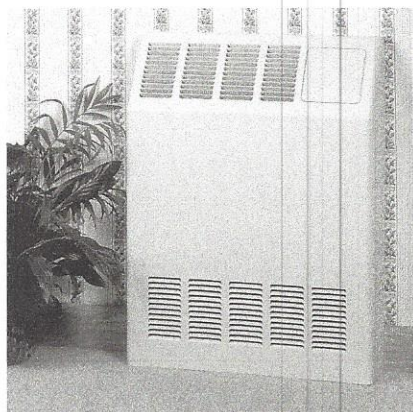

Surface models finished in Eggshell with sloped top and rounded edges.

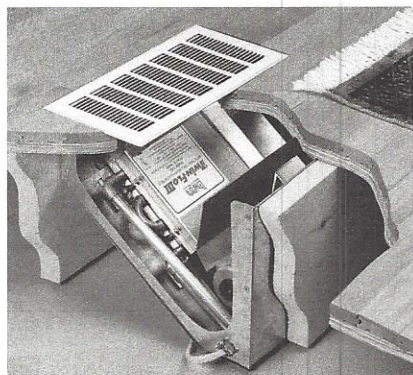

Through the Floor Kit features "heel proof" grille in Eggshell.

Recessed Wall Kit

Twin-Flo III Recessed kits fit into wall recesses so they're ideal for narrow hallways, mud rooms, laundry areas, and other tight locations. The smaller Model W42 fits in between standard 16" center studs.

- Galvanized steel inner cabinet
- Eggshell enamel finish
- Color coordinated screw covers and round edges for neat appearance

Model No.	Part No.
W42	55W42
W84	55W84
W120	55W120

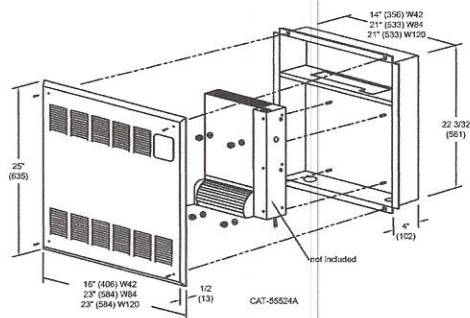

Surface Mount Kit

Twin-Flo III Surface kits install quickly and easily — directly to a wall surface. They add warmth to cold hallways, bathrooms, kitchens, laundry rooms, family rooms, work shops, and additions.

- Galvanized steel inner cabinet
- Eggshell enamel finish
- Sloped top and rounded edges for neat appearance

Model No.	Part No.
F42	55F42
F84	55F84
F120	55F120

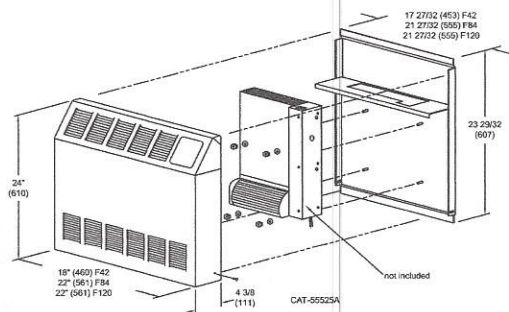

Floor Kit

Where glassed-in walls or sliders leave little room for heating units, Twin-Flo III Floor kits install easily between standard floor joists. The grille provides a choice of forward or rear directional air flow and easy accessibility for routine maintenance.

- Heavy 16 gauge steel grill can be rotated for front or rear discharge
- Protective screen under grill
- Eggshell enamel finished grille

Model No.	Part No.
FK42	55FK42
FK84	55FK84
FK120	55FK120

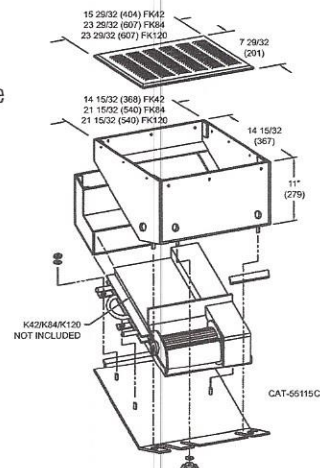

TWIN-FLO III®

Optional Grilles

Diamond Pattern Grilles

14 GA. CRS with baked enamel finish



Description	Part No.	Approx. Shipping Wt.
White Grille for K-42	BMK-03026-1DW	1.5 lbs.
White Grille for K-84	BMK-03026-2DW	1.8 lbs.
White Grille for K-120	BMK-03026-3DW	2.1 lbs.
Flat Black Grille for K-42	BMK-03026-1DB	1.5 lbs.
Flat Black Grille for K-84	BMK-03026-2DB	1.8 lbs.
Flat Black Grille for K-120	BMK-03026-3DB	2.1 lbs.

Slotted Pattern Grilles

14 GA. CRS with baked enamel finish

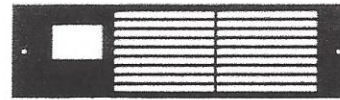
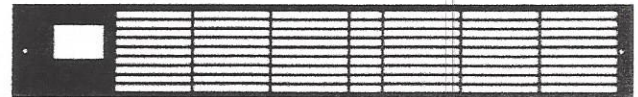

Description	Part No.	Approx. Shipping Wt.
White Grille for K-42	BMK-03026-1SW	1.5 lbs.
White Grille for K-84	BMK-03026-2SW	1.8 lbs.
White Grille for K-120	BMK-03026-3SW	2.1 lbs.
Flat Black Grille for K-42	BMK-03026-1SB	1.5 lbs.
Flat Black Grille for K-84	BMK-03026-2SB	1.8 lbs.
Flat Black Grille for K-120	BMK-03026-3SB	2.1 lbs.

Replacement Parts

Description	Part No.	Model		
		42	84	120
Motor-Fan Assembly	BMKRO2020-001	x		
	BMKRO2020-002		x	
	BMKRO2020-003			x
Standard Aquastat Assembly (120° – 105°F)	BMKRO2024-001	x	x	
	BMKRO2024-002			x
Low Temp. Aquastat Assembly (110° – 95°F)	BMKRO2024-L01	x	x	
	BMKRO2024-L02			x
Heating Element	BMKRO2017-001	x		
	BMKRO2017-002		x	
	J37R52064			x
2 Speed Fan Switch	J1TR02029-001	x	x	x
Grille (New One Piece)	BMKRO8778-B42	x		
	BMKRO8778-B84		x	
	BMKRO8778-B12			x
Louvered Front Panel (Model W only)	BMWRO2172-001	x		
	BMWRO2172-002		x	x
Louvered Front Panel (Model F only)	BMFRO2165-001	x		
	BMFRO2165-002		x	x
Louvered Floor Grille (Model FK only)	FKRO2437-001	x		
	FKRO2437-002		x	x
Quick-Connect Hose Kit	HK-10			