

Features

- 36-inch minimum base cabinet width.
- KOHLER cast iron.
- Acid-resistant enamel finish.
- Under-mount.
- Single bowl.
- No faucet holes.
- Offset drain basin slopes toward drain to minimize water from pooling.
- Self-Trimming® apron overlaps cabinet face for easy installation and beautiful results.
- 35-11/16" (907 mm) x 21-9/16" (548 mm)

Recommended Accessories

K-9000 P-Trap

Optional Accessories

K-6639 Sink Rack

K-8801 Sink Strainer



Codes/Standards

















ASME A112.19.1/CSA B45.2

KOHLER® Enameled Cast Iron Kitchen Sink - Lifetime Limited Warranty

See website for detailed warranty information.

Available Color/Finishes

Color tiles intended for reference only.

Color	Code	Description
	0	White
	FF	Sea Salt™
	96	Biscuit
	47	Almond
	FD	Cane Sugar™
	NY	Dune
	95	Ice™ Grey
	G9	Sandbar
	33	Mexican Sand™
	K4	Cashmere
	FT	Basalt
	58	Thunder™ Grey
	20	Suede
	KA	Black 'n Tan
	FP	Caviar
	7	Black Black™

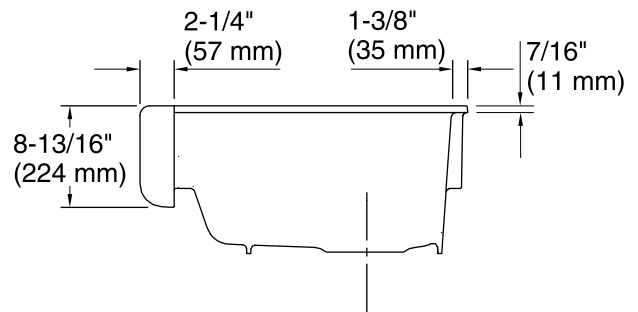
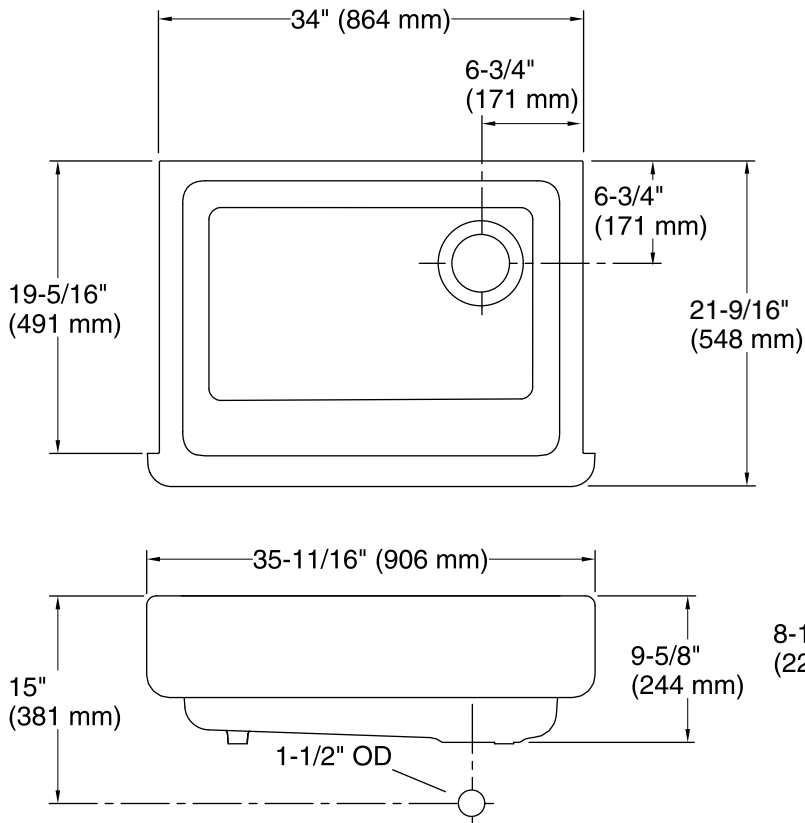

Technical Information

All product dimensions are nominal.

Bowl configuration:	Single
Installation:	Under-mount
Min. base cabinet width:	36" (914 mm)
Bowl area (Only)	Length: 30-3/4" (781 mm) Width: 18-1/16" (459 mm) Bowl depth: 9" (229 mm)
Drain hole:	3-5/8" (92 mm)
Template:	1156910-7, required, included 1157001, required, included

Notes

Install this product according to the installation instructions.

IMPORTANT! The distance from the top edge of the cabinet to the top of the cabinet door must be at least 9" (229 mm) to install this sink.