

### Features

- Real Rain Diverter Valve system actuates Real Rain's Deluge function delivering approximately 0.5 gallons in eight seconds
- Real Rain Diverter Trim kit contains both a round and square escutcheon for different design options
- Required for the K-76746 Real Rain diverter valve

### Material

- Premium metal construction for durability and reliability
- KOHLER finishes resist corrosion and tarnishing

### Installation

- Real Rain Diverter Valve is designed to be in-line between the shower valve and Real Rain Panel

### Required Products/Accessories

K-76746 Diverter Valve



ADA CSA B651 OBC

### Codes/Standards









ASME A112.18.1/CSA B125.1  
ADA  
ICC/ANSI A117.1  
CSA B651  
OBC

### KOHLER® Faucet Lifetime Limited Warranty

See website for detailed warranty information.

### Available Colors/Finishes

*Color tiles intended for reference only.*

Color	Code	Description
	CP	Polished Chrome
	SN	Vibrant® Polished Nickel
	AF	Vibrant® French Gold
	BN	Vibrant® Brushed Nickel
	BV	Vibrant® Brushed Bronze
	BL	Matte Black
	2MB	Vibrant® Brushed Moderne Brass
	TT	Vibrant Titanium
	BGP	Vibrant Brushed Graphite

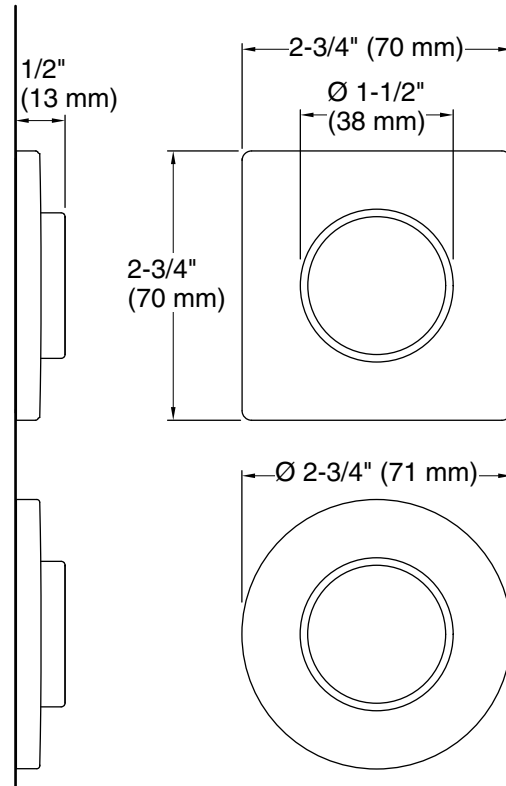

### Technical Information

All product dimensions are nominal.

### Spout:

### Notes

Install this product according to the installation instructions.

ADA, OBC, CSA B651 compliant when installed to the specific requirements of these regulations.