

Features

- A single handle controls both on/off activation and temperature setting
- Pressure-balancing diaphragm technology maintains outlet temperature within +/-3°F during water pressure fluctuations
- Antiscald protection
- Includes faceplate with ADA-compliant metal level handle
- Includes 6-9/16" (167 mm) diverter bath spout with slip-fit connection
- Includes single-function 2.5 gpm (9.5 lpm) showerhead
- MasterClean™ sprayface features an easy-to-clean surface that withstands mineral buildup
- Includes shower arm and flange
- Coordinates with other products in the Tone collection
- Requires Rite-Temp™ pressure-balancing valve (sold separately)

Material

- Premium material construction with metal handle ensures reliability and durability
- KOHLER finishes resist corrosion and tarnishing

Adapters, Rough-in and Extension Kits

10350

Range: 3-1/2" (89 mm) -
4-1/4" (108 mm)



Codes/Standards







ASME A112.18.1/CSA B125.1
DOE - Energy Policy Act 1992

KOHLER® Faucet Lifetime Limited Warranty

See website for detailed warranty information.

Available Colors/Finishes

Color tiles intended for reference only.

Color	Code	Description
	CP	Polished Chrome
	BN	Vibrant™ Brushed Nickel
	BL	Matte Black
	2MB	Vibrant™ Brushed Moderne Brass
	BMB	Matte Black with Moderne Brass
	CBL	Matte Black with Polished Chrome

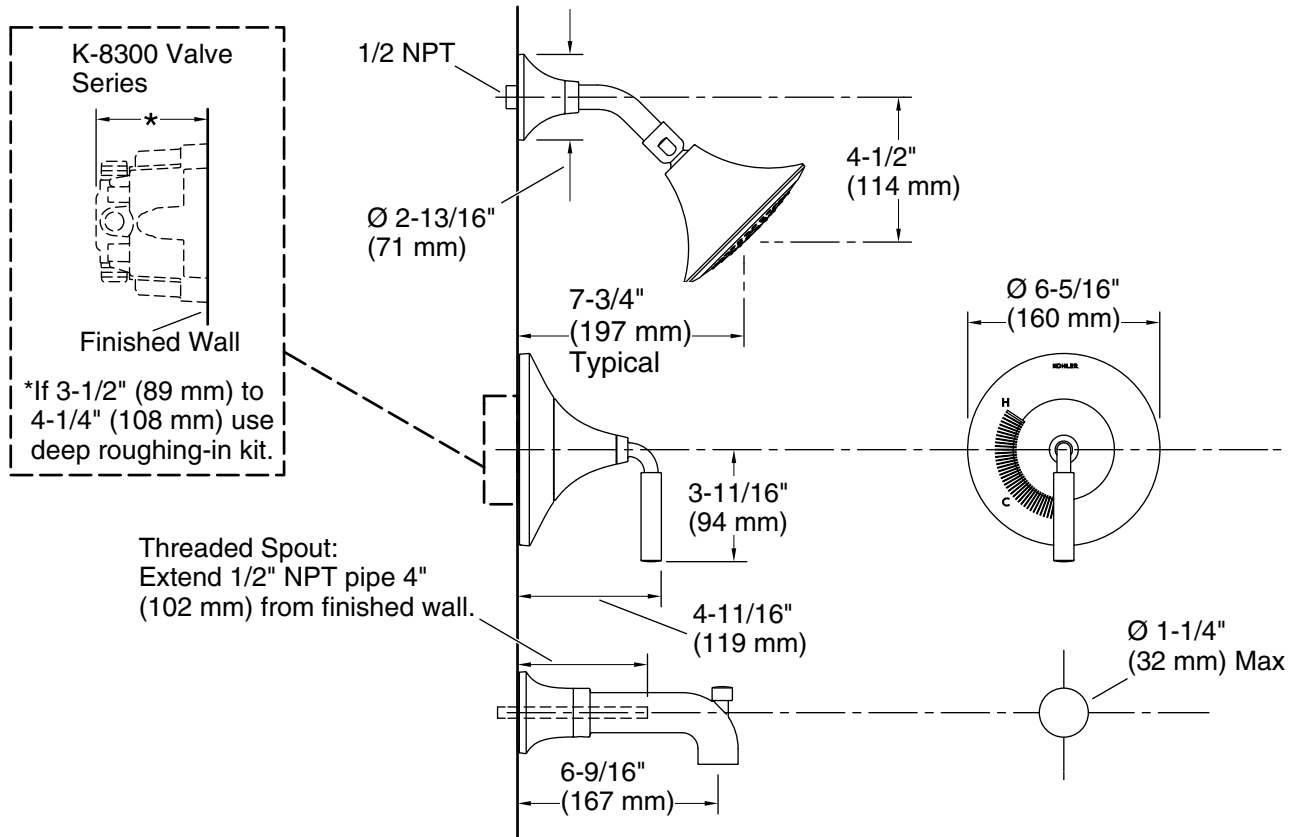

Technical Information

All product dimensions are nominal.

Drain included: No

Spout:

Spout reach: 6-9/16" (166 mm)

Showerhead/Body Spray:

Rated maximum flow: 2.5 gal/min (9.5 l/min)

Pressure: 45 psi (3.1 bar)

Notes

Install this product according to the installation instructions.