

### Features

- Single-function oblong rainhead features Full Coverage with Katalyst technology, a drenching spray experience ideal for rinsing shampoo from hair
- MasterClean™ sprayface features an easy-to-clean surface that withstands mineral buildup and maximizes spray performance
- Optimized sprayface for maximum performance
- 1.75 gpm (6.6 lpm) maximum flow rate at 80 psi (5.5 bar)
- This product can help a building earn Water Efficiency points in LEED® Green Building Rating System

### Material

- Premium material construction for durability and reliability
- KOHLER finishes resist corrosion and tarnishing

### Technology

- Katalyst® air-induction technology infuses water with air, creating bigger drops for a more powerful spray

### Installation

- 1/2" -14 NPT connection
- Requires single-function rainhead shower arm and flange (sold separately)

### Required Products/Accessories

K-26319 3" ceiling-mount single-function rainhead arm and flange

or

K-26320 6" ceiling-mount single-function rainhead arm and flange

or

K-26321 12" ceiling-mount single-function rainhead arm and flange

or

K-26322 15-1/2" wall-mount single-function rainhead arm and flange

or

K-26307 19" wall-mount single-function rainhead arm and flange



### Codes/Standards









ASME A112.18.1/CSA B125.1  
DOE - Energy Policy Act 1992  
EPA WaterSense®  
California Energy Commission (CEC)

### KOHLER® Faucet Lifetime Limited Warranty

See website for detailed warranty information.

### Available Colors/Finishes

*Color tiles intended for reference only.*

Color	Code	Description
	CP	Polished Chrome
	SN	Vibrant® Polished Nickel
	AF	Vibrant® French Gold
	BN	Vibrant® Brushed Nickel
	BV	Vibrant® Brushed Bronze
	BL	Matte Black
	2MB	Vibrant® Brushed Moderne Brass
	TT	Vibrant Titanium
	BGP	Vibrant Brushed Graphite

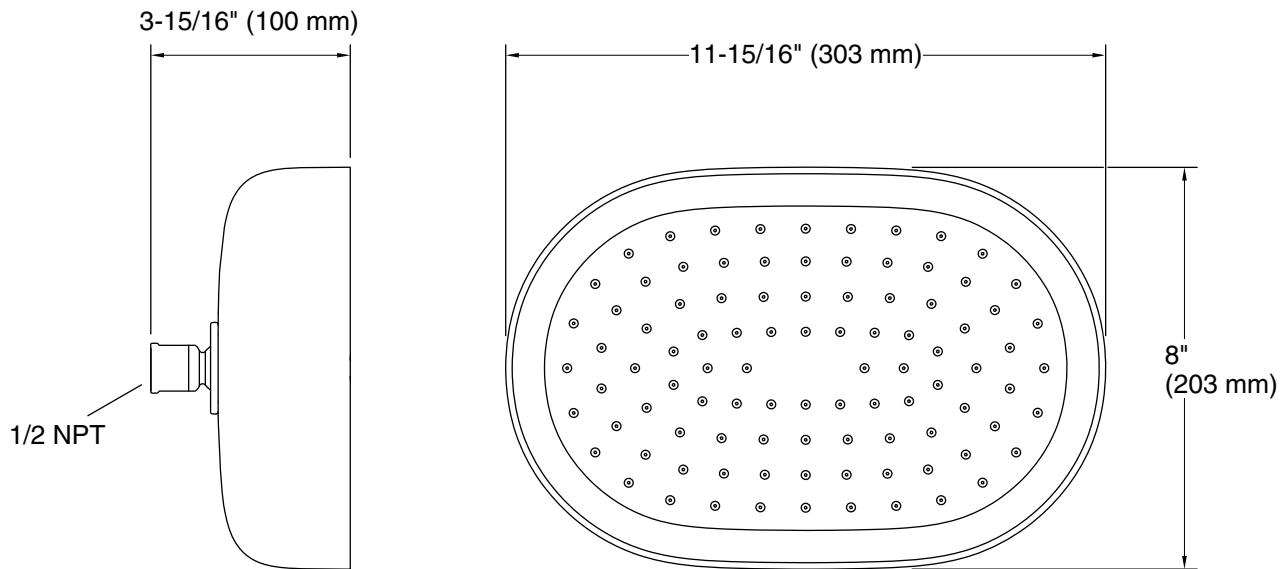

**Technical Information**

All product dimensions are nominal.

**Spout:**

Shower/Rainhead rated max flow: 1.75 gal/min (6.6 l/min)

**Notes**

Install this product according to the installation instructions.